



Track-It™ Pressure/Temp and Vacuum/Temp Data Loggers with Display

SAFEGUARDS AND PRECAUTIONS:



Read and follow all instructions in this manual carefully, and retain them for future reference.

Do not use this instrument in any manner inconsistent with these operating instructions or under any conditions that exceed the environmental specifications stated.

1.0 DESCRIPTION

The Track-It Pressure/Temperature and Vacuum/Temperature Data Loggers with Display are battery powered standalone watertight compact data loggers that emulate a pressure gauge. They can be configured to record both Pressure and Temperature up to 130,000 samples or Pressure alone, to maximize data storage space. Real time data, alarms and min/max information can be displayed on the multi-line LCD. The unit is easily configured using the free downloadable Track-It PC Software. There is a mini-USB connector on the rear of the unit allowing connection to a PC for programming and data upload. Data upload can also be done with a device for Android™ using the Transporter App available on the Google Play™ store.



The logger can be programmed to record data from once every two seconds to once a day. The recording can be initiated by the user to commence immediately, manually via the keypad buttons, at some preset time in the future, or on an alarm condition.

The display can be programmed to display pressure in various engineering units depending on pressure range. It can also display temperature, minimum and maximum values, percentage of memory used, time and date.

Track-It Pressure/Temp and Vacuum/Temp Data Loggers are packaged in a rugged watertight anodized aluminum and stainless steel housing and have a standard 1/4" NPT fitting. The replaceable internal lithium battery has up to a 3 year life.

2.0 TRACK-IT PC SOFTWARE

IMPORTANT: Before using your Track-It Data Logger you must first download and install the **USB Drivers and PC Software**. Please refer to the Quick Start Guide that was provided with your data logger or you can download the Quick Start Guide here: http://monarchinstrument.com/pdfs/Quick_Start_Guide.pdf

The free Track-It PC Software allows the user complete control in programming the logger and allows for the upload, examination and archiving of data recorded on the logger. Some of the features are:

- Delayed recordings, fixed duration recordings by time or number of samples, multiple record times, manual record by button press, record on alarms
- Sample rates from 2 seconds to 24 hours. Instantaneous, average, maximum or minimum values
- Two Alarms, high or low, latched or momentary and record under these alarm conditions
- Display of data graphically, digitally or tabular formats with alarm indication
- Export user selected data in CSV formats for import into Excel®. Filter data to be exported.

Specifics relating to these Loggers can be found [below](#).

Track-It Software is available at: http://monarchinstrument.com/Software/Track-It_Software.zip

3.0 TRACK-IT TRANSPORT APP

 Track-It Transport is a free Application for Android that allows you to use your device for Android to start and stop recording and transfer data using a USB On-the-Go cable.



<https://play.google.com/store/apps/details?id=com.trackit.transporter>



Scan for Application
for Android

4.0 INSTALLATION

The logger can be ordered with various pressure sensors to cover most applications. Sensors have a 1/4" NPT thread that is intended to screw into the pressure source. Make sure to use suitable tape or thread sealant/dope on the threads before inserting the logger into the port. Use an adjustable wrench on the **SENSOR NUT** to tighten the device into the port and test for leaks.

Once installed the dial can be rotated 300 degrees about the sensor to the intended viewing direction. The gauge face can also be rotated 360 degrees by undoing the blue bezel, lifting the front panel and associated electronics and rotating it to the desired position. Ensure the O-ring is in place before replacing the bezel. Do not stress any of the internal wiring.



5.0 BATTERY



The unit operates off a 1/2 AA 3.6V Lithium battery. The battery is accessed by removing the rear bezel ring and cover. Gently extract the battery and replace as needed. **NOTE POLARITY WHEN REPLACING** – the unit will not operate if the battery is reversed. Ensure the O-ring is in place before replacing the cover and bezel. Do not stress any of the internal wiring.

6.0 BUTTONS AND MENU

If the display is off, pressing any button will turn it on for the duration set in the Track-It PC Software. If the backlight is turned on, it will light for approximately 5 seconds.

There are 3 buttons: ◀ (left arrow),  MENU and ▶ (right arrow).

Pressing the ◀ or ▶ buttons will scroll the display through the various display values as set in the Track-It PC Software. This includes Pressure, Temperature, Date/Time, Memory Usage, Max/Min for Pressure and/or Temperature.

6.1 Menu Modes

There are two menu modes: the **Regular** menu and the **Admin** menu. What is visible in each menu is a function of how the device is programmed using the PC software. See details [below](#). Some menu items are context sensitive.

The **Regular** menu is accessed by pressing the  MENU button.

The **Admin** menu is accessed by pressing and holding the ◀ (left arrow) button then pressing the  MENU button.



In the menu mode the ◀ button is the escape or exit button, the ▶ button is the accept/change button and the MENU button will move to the next menu item. The display will automatically exit back to the real time display if there is no activity for 10 seconds.

The content of each menu is set up in the Track-It PC Software. In addition, the admin menu can be locked in which case the user at the logger cannot enter this menu and will receive a LOCK message. See details [below](#).

6.2 Menu Options

(In alphabetical order – the actual order in which these items appear is dependent on settings in the Track-It PC Software)

Back Light	BKLT – AUtO/OFF – In Auto Mode the backlight will come on for 5 seconds each time a button is pressed. Turn off to conserve battery. Press ▶ button to toggle auto/off status.
Clear Alarm	Clr ALRM – Will clear any pending Alarm. Press ▶ button to clear. (Only visible during Alarm.)
Clear Minimum	Clr MIN – Will clear minimum values for Pressure and/or Temperature. Press ▶ button to clear. It depends on whether Pressure or Temperature is displayed when menu is pressed and if Pressure maximum is selected in the display menu in the Track-It Software.
Clear Maximum	Clr MAX – Same as above for Maximum.
Cycle Mode	CYCL – On/OFF – If on display will toggle between Pressure and Temperature.
Bar Graph	BAR – On/OFF – Turns the bar graph on or off. Press ▶ button to toggle on/off status.
Decimal Point	DCPT – AUtO, 0, 1 – Used to set preferred number of decimal places. Auto will use all the digits and adjust the number of digits after the decimal accordingly.
Engineering Units	Unit – Used to change the engineering units for the pressure display. The lower line will show the current engineering units. Use the ▶ to scroll through the available units and press ◀ to accept. Not all units are available depending on the full scale value of the sensor. The choice is limited by the number of digits on the display.
Record On/Off	rEC – ON/OFF – Will toggle the record mode of the unit (Only visible if record mode set to “Button Press” in the Track-It PC Software). Press ▶ button to toggle on/off status.
Zero Mode	ZERO – OFF/EnAb – Will enable the zero offset feature. Available only in the Admin menu. If Off (not enabled) the Zero Set menu item will not display.
Zero Set	ZERO – SEt/OFF – Will set the current Pressure value to zero (offset into relative mode). Press ▶ button to toggle between modes. SEt will activate relative mode, OFF will set to absolute mode. NOTE: When set, the OFS icon will show on the display. This menu item is only visible if the Zero Mode is enabled in the Admin menu and the Admin menu is NOT Locked.

7.0 LCD DISPLAY

The display has 4½ 7-segment digits to show actual values of pressure and temperature. There is also a line of 4 alphanumeric digits used to display ASCII text (e.g. Pressure Units). The display is optionally backlit; the back light is initiated for 5 seconds by pressing any button. If the pressure is greater than 19999, the resolution is set to 10 units and is indicated by the x10 icon. The maximum value displayed is therefore 199990.

There is a bar graph at the top of the display (which can be turned off by the user) giving an analog indication of values relative to 100% which is the full scale value of the sensor. Note that in the pressure offset mode the bar graph indicates the absolute value of the pressure as a function of full scale.

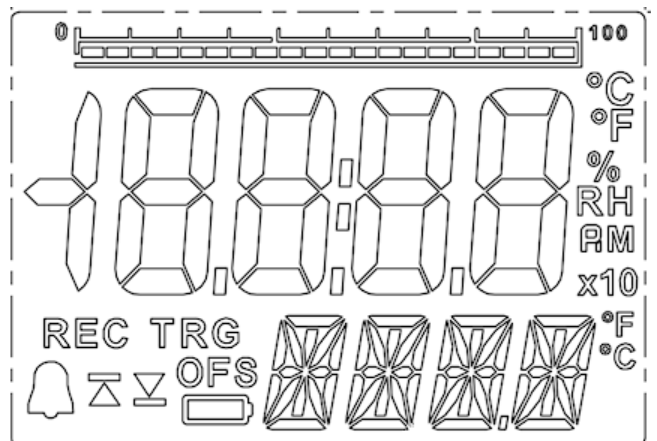

In addition to these values, the display can be scrolled using the ◀ or ▶ buttons and may show (depending on configuration) minimum and maximum values of pressure and temperature, date as day/month - 24.07 or month/day - 07.24, time in 12 or 24 hour format (12 hour format will be indicated by AM or PM – 08:30 AM), and memory usage as a % of available memory. Values shown are set in the display setup using the Track-It PC Software. See below for [details](#).





There are various icon indications on the display that indicate the following:

REC Indicates the unit is currently recording. This icon will blink at a 2 second rate.

TRG Indicates the unit is currently triggered and waiting to record. Record is initiated by time delay or button depending on configuration.

 Indicates an Alarm condition.  Indicates High Alarm.  Indicates Low Alarm

 On its own (no Alarm) indicates Maximum value. Visible when scrolling through display if set.

 On its own indicates Minimum value. Visible when scrolling through display if set.

OFS Indicates the reading has been offset and is relative. (Zero mode active).

 If present, this indicates the battery is low and should be replaced. If it is blinking it indicates readings may be compromised, unit may shut down and the battery should be replaced immediately.

x10 Indicates the current numerical value displayed must be multiplied by 10.



Bar graph shows percentage of full scale (0 to 100%) of the value indicated. This can indicate Pressure, Temperature or percentage of memory used when recording. Note that in the Pressure offset mode the bar graph will show the percentage of full scale of the absolute value not the offset value currently displayed. The bar can be disabled in the menu.

8.0 LED

There is an LED (Light Emitting Diode) above the display to the left. This LED is user programmable using the Track-It PC Software ([see below](#)) and can indicate that the unit is recording (Green blink) or an Alarm condition exists (Red blink). It will also blink green when serial communication is taking place through the USB port.

9.0 TRACK-IT SOFTWARE

The Track-It Software runs on a PC and enables the user to upload data, customize and program the Logger through a USB connection. The operation of the Track-It Software is described in its own manual which is accessed via the Help - Manual option.

There are a number of unique options specifically for this Display Pressure Logger which are covered below.

9.1 Preferences

Select "Preferences" then the Eng Units tab. You will see the pop-up box shown right.

These Engineering Units apply to the data **read** from the Logger and displayed on the graph or in the data table.

If the "Units from Logger" box is **checked** - the selection of engineering units here is ignored and the engineering units used will be as set by default in the Logger. If the "Units from Logger" box is **unchecked** then the unit selected here will override that set in the Logger.

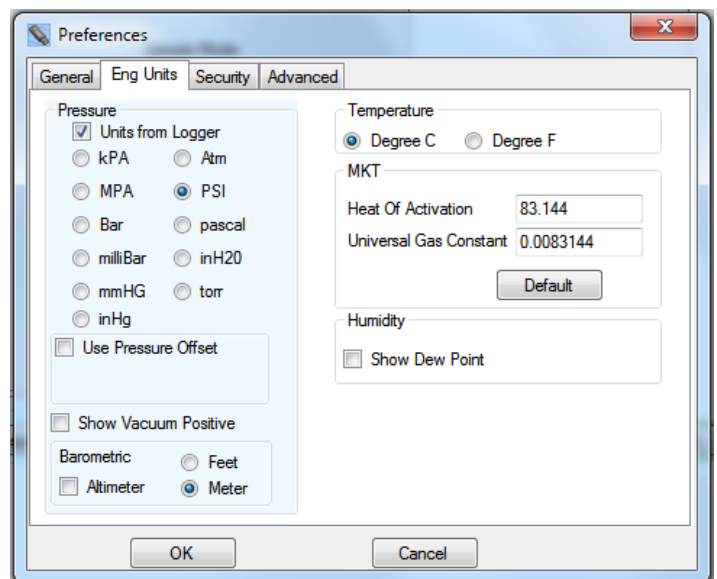

9.2 Input Setup

Under the “Device Setup” tab select the “Input” tab and the “Chan 1” tab.

This setting allows the user to select the default engineering units that will be displayed on the Logger LCD Display. Note that not all engineering units are available; it depends on the full-scale range of the pressure sensor, as some values will be too large to display on the Logger. Note also that these units may be changed locally at the Logger if the menu is set up to allow this. See below.

The units selected here will be used when reading data from the Logger unless overridden in the Preferences menu.

The Pressure channel cannot be disabled – the Logger will always record Pressure.

Note that selecting anything other than “Instantaneous” for Sample Mode (the Logger only takes a reading at the Record Rate) will cause the Logger to take readings at the highest sample rate and will have an adverse effect on the battery life.

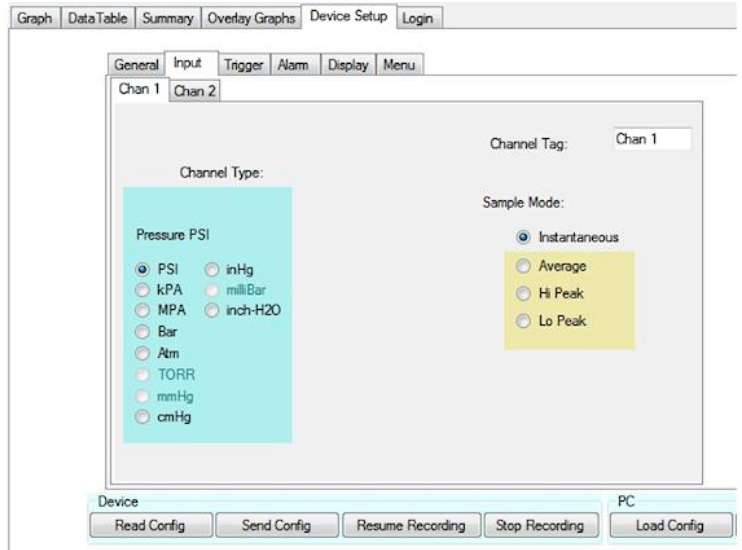

The “Chan 2” tab is similar but for the Temperature channel. The Temperature channel can be disabled in which case the Logger will only record Pressure, not Temperature and Pressure.

9.3 Display Setup

Under the “Device Setup” tab select the “Display” tab.

These settings allow the user to decide what is displayed on the Logger LCD display and defines the function of the LED.

The “Display List” column shows the available functions that are available to be displayed on the Logger and the “LCD Display” column are the functions that will be displayed on the Logger. The user can move the options between the columns by selecting the option (clicking on it) and using the arrow keys. Note that Pressure cannot be moved from the LCD display.

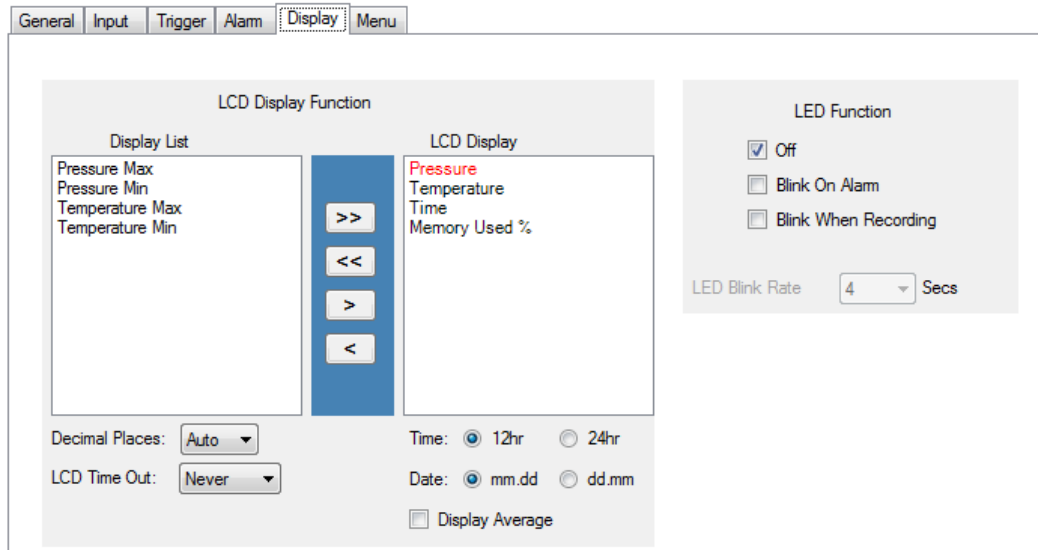

“Decimal Places:” will define how the data is displayed. Auto will always use the maximum number of digits available.

“LCD Time Out:” determines how long the LCD display will be on before blanking. **Note** that as long as the LCD display is on, the Logger updates the readings in real-time which has an adverse effect on battery life.

The “Time:” and “Date:” formats can be selected as shown.

The “Display Average” checkbox enables the real-time update to be a rolling average of the last four readings. This will quiet a noisy display but does affect the response of the readout.

9.4 Menu Setup

Under the “Device Setup” tab select the “Menu” tab.

This setting allows the user to determine which menu functions appear in the Normal menu and which appear in the Admin menu. Menu items will appear in the Logger menus in the order of top to bottom in the below lists. By highlighting a menu item (clicking on it) the user can manipulate its position using the arrow buttons. The Zero Mode cannot be moved from the Admin menu

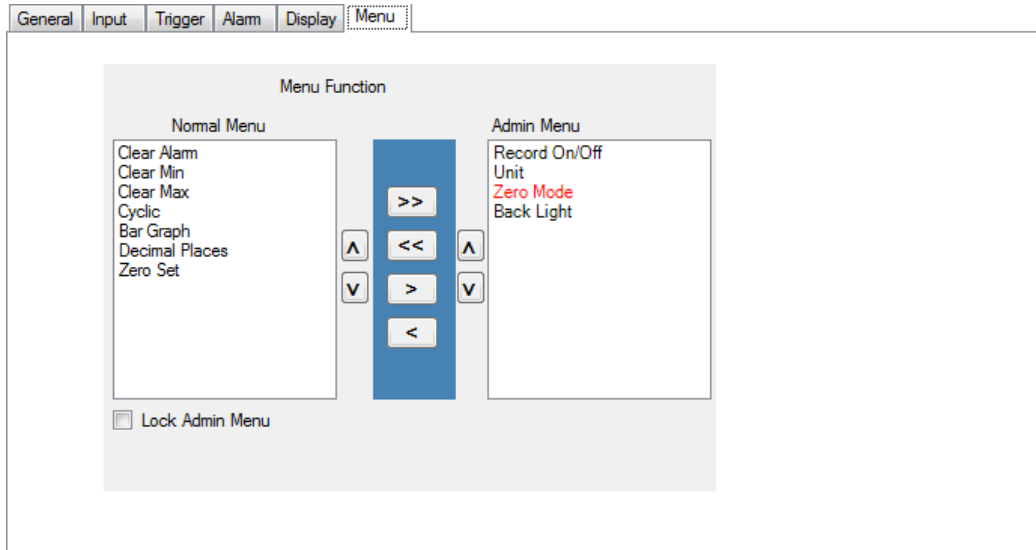

If the “Lock Admin Menu” box is checked the user will not be able to access the Admin Menu features at the Logger, and the Zero Set menu option (display offset) will not be available in the Normal Menu.

This space intentionally left blank

10.0 SPECIFICATIONS

10.1 General

Record:	Sample Rates: User configured 1 every 2 seconds up to 1 every 24 hours No. of Samples: 130,000 (depends on setup)
Record Trigger:	Two independent triggers. Multiple trigger modes: Instantaneous, button control, on alarm, time and date (start and stop), day of week
Record Mode:	Fill to end of memory or cyclic, number of samples, time duration
Display:	Two line, 4½ digit 7 segment LCD and 5-digit alphanumeric display with custom icons, multi-segment bar graph for 0-100% indication, backlit
Alarms:	2 user programmable alarms. High or Low
Communication:	Mini USB connection
Software:	Track-It Software—Program device, view data (historic or real time), export to spreadsheet.
Battery:	Lithium 1/2AA 1.2Ah Life: Up to 3 years typical @ 1 minute sample rate (LCD off)
Enclosure:	Material: Anodized Aluminum and 316L Stainless Steel Dimensions: 2.94" (74.6mm) diameter x 1.82" (46.3mm) deep x 4.78" (121.4mm) tall including port threads

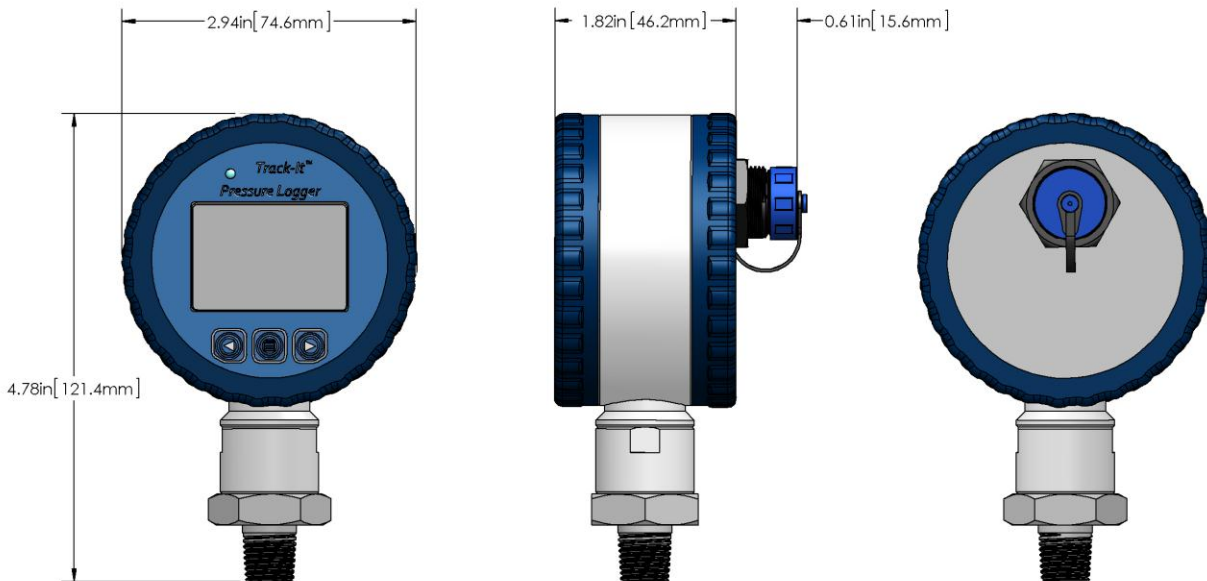

10.2 Measurement

Ranges:	Pressure: 0-35, 0-150, 0-350, 0-550, 0-2000, 0-5800 PSI Vacuum: 760-0 Torr and 760-380 Torr
Accuracy:	± 0.25%
Resolution:	0.01%
Overpressure Rating:	1.5 times max
Port connection:	1/4" NPT Male
Temperature Range:	-20 to +85°C / -4 to 185°F
	Accuracy: ± 0.5°C 0 to 50°C / 32 to 122°F ± 2°C -20 to 85°C / -4 to 185°F
	Resolution: 0.1°C / 0.2°F

11.0 ACCESSORIES

Battery	Replacement Lithium 1/2AA 1.2 AH Battery (ER14250)
O-Rings	Replacement O-Ring Seal, 2-Pack
Garden Hose Adapter	Brass Coupling
USB 2.0 Cable	USB 2.0 to 2.0 mini 3-foot cable
USB On-The-Go Cable	USB Cable for use with Android devices
Track-It Software	Track-It Software on CD



In order to comply with EU Directive 2002/96/EC on Waste Electrical and Electronic Equipment (WEEE):

This product may contain material which could be hazardous to human health and the environment. DO NOT DISPOSE of this product as unsorted municipal waste. This product needs to be RECYCLED in accordance with local regulations, contact your local authorities for more information. This product may be returnable to your distributor for recycling - contact the distributor for details.

CE Compliant. RoHS Compliant. Meets the safety requirements of IEC61010-1.

Monarch Instrument's Limited Warranty applies. See www.monarchinstrument.com for details.
Warranty Registration and Extended Warranty coverage available online at www.monarchinstrument.com.

Monarch Instrument

15 Columbia Drive
Amherst, NH 03031 USA
Phone: (603) 883-3390
Fax: (603) 886-3300
E-mail: support@monarchinstrument.com
Website: www.monarchinstrument.com

Track-It is a trademark of Monarch Instrument.

Android and Google Play are trademarks of Google Inc.

The Android robot is reproduced or modified from work created and shared by Google and used according to terms described in the Creative Commons 3.0 Attribution License.

Excel is either a registered trademark or trademark of Microsoft Corporation in the United States and/or other countries.
